

FAC



FAC SEGURIDAD S.A.

Garantiza sus productos de forma generalizada por un periodo de 2 AÑOS de conformidad con la legislación vigente

Sin embargo, en el presente Catálogo General de Producto, encontrará productos en los que FAC SEGURIDAD S.A. extiende la garantía hasta 5 AÑOS desde la fecha de adquisición

Podrá identificar el producto con el símbolo  junto al mismo

According to the current legislation, FAC SEGURIDAD S.A., guarantees its products for 2 YEARS in general

However, in this catalogue you will find products on which FAC SEGURIDAD S.A. increases this warranty to 5 YEARS from the date of purchase

You will be able to identify the specific product through the near symbol 

FAC SEGURIDAD S.A. garante, em conformidade com a legislação em vigor, os seus productos de uma forma peral, por um período de 2 ANOS





Não obstante, no presente Catálogo Peral, encontrará productos nos quais a FAC SEGURIDAD, S.A. extiende a garantía até 5 ANOS, a contar da data de compra

Poderá identificar este producto pelo símbolo  junto al mismo



ÍNDICE

INDEX

	CERROJOS	5
	<i>LOCKING BOLTS FERROLHOS</i>	
	CERRADURAS DE EMBUTIR EN MADERA	31
	<i>HIGH SECURITY MORTICE LOCKS FECHADURAS DE EMBUTIR MADEIRA</i>	
	CERRADURAS DE SOBREPONER	37
	<i>RIM LOCKS FECHADURAS DE SUPERFICIE</i>	
	CERRADURAS DE EMBUTIR EN PERFIL METÁLICO	45
	<i>METALLIC MORTICE LOCKS FECHADURAS PARA PORTA METÁLICA</i>	
	CERRADURAS ELÉCTRICAS Y ELECTRÓNICAS	49
	<i>ELECTRIC LOCKS FECHADURAS ELÉCTRICAS</i>	
	CERRADURAS DE GARAJE	51
	<i>GARAGE LOCKS FECHADURAS DO GARAGE</i>	
	CILINDROS DE PERFIL EUROPEO	55
	<i>EUROPROFILE CYLINDERS CANHAOS DE PERFIL EUROPEO</i>	
	CIERRAPUERTAS	61
	<i>DOOR CLOSERS FECHA PORTAS</i>	
	CANDADOS	63
	<i>PADLOCKS CADEADOS</i>	
	CAJAS FUERTES DE EMPOTRAR	73
	<i>MORTICE SAFES COFRES DE EMBUTIR</i>	
	CAJAS FUERTES DE SOBREPONER	95
	<i>FREE STANDING SAFES COFRES SUPERFICIE</i>	
	CAJAS FUERTES DECORATIVAS	115
	<i>DECORATIVE STRONG SAFES COFRES FORTES DECORATIVOS</i>	
	CAJAS FUERTES PROFESIONALES	121
	<i>PROFESSIONAL STRONG SAFES COFRES FORTES PROFESSIONAIS</i>	
	CAJAS IGNÍFUGAS	141
	<i>FIREPROOF SAFES COFRES ANTIFOGO</i>	
	CAUDALITAS, ARMARIOS PORTALLAVES BUZONES, EXPOSITORES Y ESPECIALES	147
	<i>CASH BOXES, KEY BOXES, LETTERS BOXES AND STAND DISPLAYS COFRES PORTÁTIES, CHAVEIROS, CAIXAS DE CORREIO E EXPOSITORES</i>	
	ESPECIALES	157
	<i>SPECIAL ITEMS ESPECIALES</i>	

CERTIFICADOS DE EMPRESA

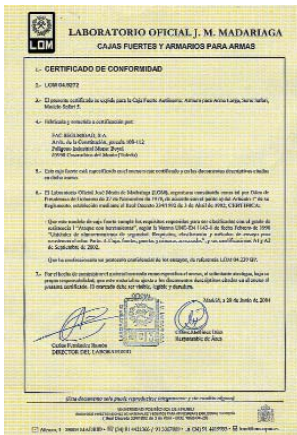

EMPRESA MIEMBRO DE:



Comité Técnico de Certificación de AENOR

AEN/CTC-055 Productos de Seguridad Física y Elementos de Cierre

Comité Técnico de Normalización de AENOR

AEN/CTN-108 Seguridad Física, Cerraduras y Dispositivos de Maculación

CERROJOS

LOCKING BOLTS
FERROLHOS

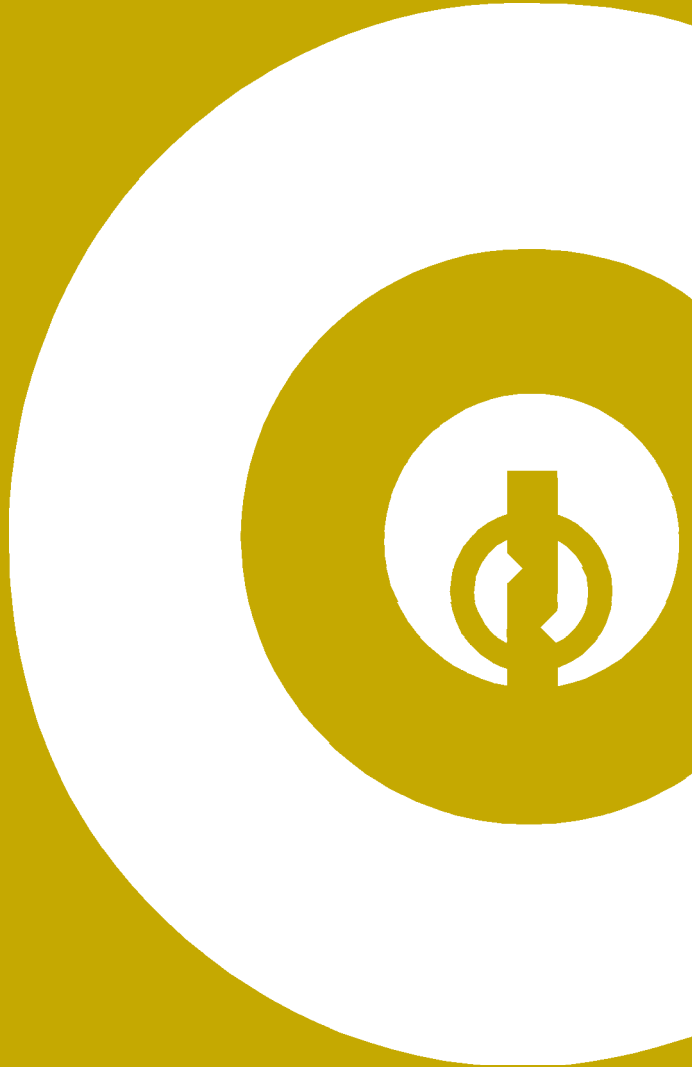





FAC

SISTEMAS Y FUNCIONES DE CERROJOS

SYSTEMS AND FUNCTIONS OF LOCKING BOLTS

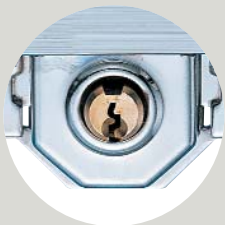
SISTEMAS E FUNÇÕES DOS FERROLHOS

	Sistemas <i>System</i> <i>Sistemas</i>	Modelos <i>Models</i> <i>Modelos</i>	Funciones <i>Functions</i> <i>Funções</i>
	Sistema C	91 C	Se acciona con la llave únicamente por la parte interior quedando siempre la barra fija <i>It's worked by a key only inside</i> <i>São accionados por chave unicamente pelo lado interior ficando a barra sempre fixa</i>
	Sistema R	50 R 101 R 201 R 300 R 301 R 305 R 307 R 308 R 427 R 428 R 101 RP 301 RP 301 RCP 305 RP 307 RP 308 RP	Se acciona por la parte interior con la mano. Para ello se oprime el botón que hay debajo de la barra, a la vez que se empuja el tirador. El exterior funciona con la llave <i>It's worked inside manually pushing a button and outside turning the key</i> <i>São accionados pelo lado interior premindo o botão e empurrando a barra e pelo lado exterior com chave</i>
	Sistema L	101 L 201 L 301 L 302 L 303 L 306 L 307 L 301 LP 304 DF	Se acciona interior y exteriormente con llave, quedando siempre la barra fija <i>It's worked inside and outside turning the key</i> <i>São accionados pelo lado interior e exterior com chave</i>
	Sistema T	302 T 303 T 304 F 304 FP Nº 1 301 RP Transport	Por el interior se acciona con la mano, por el exterior funciona con la llave. La barra queda libre en posición de abierto y fijo en posición de cerrado <i>It's worked inside manually and outside with the key</i> <i>São accionados pelo lado interior empurrando a barra e pelo lado exterior com chave</i>

FAC 91C / 80 SISTEMA C

CERROJOS
LOCKING BOLTS
FERROLHOS

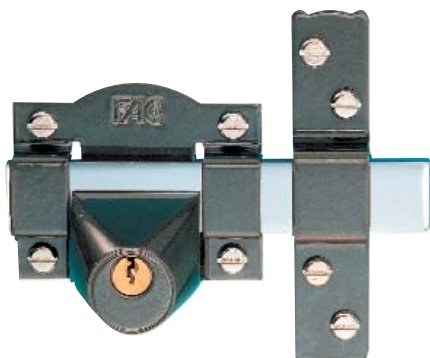

- A 86
- B 78
- C 43
- D 126
- E 26
- F 140
- G 38

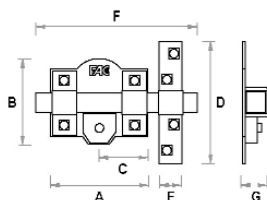

Bombillo 38 mm

		Código de Barras	Ref.	Embalaje
Pintado	(caja)	8422621012002	01200	12
	(blister)	8422621014006	01400	6

Acabado pintado
Barra en pletina de acero de 25x10 mm
Placa en acero de 2 mm
Cerradero en acero de 3 mm
Cilindro de latón de 38 mm de longitud

Painted finish
Steel bar of 25x10 mm
2 mm steel plate
3 mm steel striking plate
Brass cylinder: 38 mm length

Acabamento pintado
Barra em aço de 25x10 mm
Placa em aço de 2 mm
Trocador em aço de 3 mm
Cilindro em latão de 38 mm de longitude



Llave de 5 claves interior
5 pins key - Internal
Chave de 5 pinos

FAC 50R / 80 SISTEMA R



- A 86
- B 76
- C 43
- D 126
- E 26
- F 140
- G 40
- 50

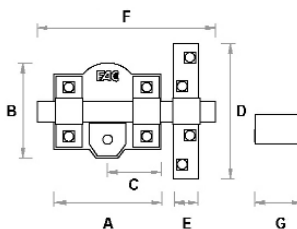

Bombillo 40 mm

		Código de Barras	Ref.	Embalaje
Niquelado	(blister)	8422621010084	01008	12

Bombillo 50 mm

		Código de Barras	Ref.	Embalaje
Niquelado	(caja)	8422621010046	01004	12
	(blister)	8422621010022	01002	12

Acabado niquelado
Barra de 10 mm en chapa de acero de 2 mm
Placa en acero de 2 mm
Cerradero en acero de 3 mm
Cilindro de latón de 50-40 mm de longitud
Para puertas de interior

Nickel plated finish
10 mm bar in steel plate of 2 mm
2 mm steel plate
3 mm steel striking plate
Brass cylinder: 50-40 mm length
Recommended on interior doors

Acabamento niquelado
Barra de 10 mm em aço de 2 mm
Placa em aço de 2 mm
Trocador em aço de 3 mm
Cilindro em latão de 50-40 mm de longitude
Em portas do interior



Llave de 5 claves interior
5 pins key - Internal
Chave de 5 pinos

CERROJOS
LOCKING BOLTS
FERROLHOS

8

Acabado pintado y niquelado
Barra en acero calibrado de 18 mm
Placa en acero de 2 mm
Cerradero en acero de 3 mm
Cilindro de latón de 50-70 mm
de longitud

Painted and nickel plated finish
18 mm steel bar
2 mm steel plate
3 mm steel striking plate
Brass cylinder: 50-70 mm length

Acabamento pintado e niquelado
Barra em aço de 18 mm
Placa em aço de 2 mm
Trocador em aço de 3 mm
Cilindro em latão de 50-70 mm
de longitud

FAC 101R / 105
SISTEMA R

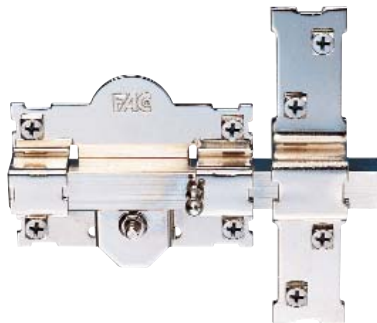

A	105
B	87
C	52
D	150
E	33
F	161
G	50
	70

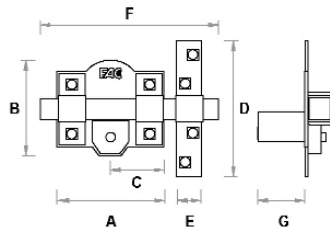

Bombillo 50 mm

	Código de Barras	Ref.	Embalaje
Pintado	(caja) 8422621010534	01053	12
Niquelado	(caja) 8422621010541	01054	12

Bombillo 70 mm

	Código de Barras	Ref.	Embalaje
Pintado	(caja) 8422621015591	01559	12
Niquelado	(caja) 8422621015614	01561	12

Bombillo 90 mm

	Código de Barras	Ref.	Embalaje
Pintado	(caja) 8422621018592	01859	12
Niquelado	(caja) 8422621018615	01861	12



Llave de 7 claves Exterior
7 pins key - External
Chave de 7 pinos

FAC 101R / 105 GARAJE
SISTEMA R



A	105
B	87
C	52
D	150
E	33
F	500
G	50

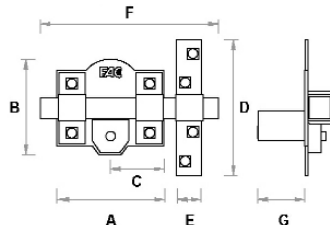

Acabado pintado
Barra en acero calibrado de 18 mm
Placa en acero de 2 mm
Cerradero en acero de 3 mm

Painted finish
18 mm steel bar
2 mm steel plate
3 mm steel striking plate

Acabamento pintado
Barra em aço de 18 mm
Placa em aço de 2 mm
Trocador em aço de 3 mm

	Código de Barras	Ref.	Embalaje
GARAGE 40			
Pintado	(caja) 8422621010565	01056	15



Llave de 7 claves Exterior
7 pins key - External
Chave de 7 pinos

FAC 101R / 105 DELTA SISTEMA R

CERROJOS
LOCKING BOLTS
FERROLHOS

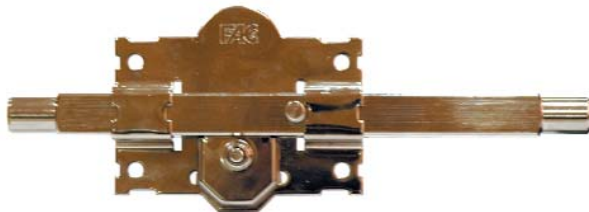

- A 105
- B 87
- C 52
- D 150
- E 33
- F 240
- G 50

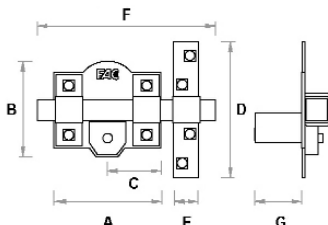

101R / DELTA		Código de Barras	Ref.	Embalaje
Niquelado	(caja)	8422621010527	01052	12
Pintado	(caja)	8422621010572	01057	12
101R / DELTA		Código de Barras	Ref.	Embalaje
Niquelado	(caja)	8422621010589	01058	12
Pintado	(caja)	8422621010596	01059	12



Llave de 7 claves Exterior
7 pins key - External
Chave de 7 pinos

Acabado pintado y niquelado
Barra en acero calibrado de 18 mm
Placa en acero de 2 mm
Cerradero en acero de 3 mm

*Painted and nickel plated finish
18 mm steel bar
2 mm steel plate
3 mm steel striking plate*

*Acabamento pintado e niquelado
Barra em aço de 18 mm
Placa em aço de 2 mm
Trocador em aço de 3 mm*

FAC 201R / 80 SISTEMA R



- A 85
- B 82
- C 42
- D 150
- E 33
- F 142
- G 50
- 70

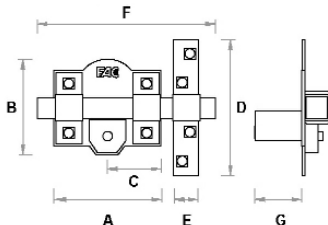

Bombillo 50 mm		Código de Barras	Ref.	Embalaje
201R / 80				
Pintado	(caja)	8422621011869	01186	12
Niquelado	(caja)	8422621011876	01187	12
Dorado	(caja)	8422621011883	01188	12
201R G.C.M.				
Niquelado	(caja)	8422621011920	01192	12
201R U.F.G.				
Pintado	(caja)	8422621011937	01193	12
201R A.C.				
Niquelado	(caja)	8422621011944	01194	12
201R C.Y.-II				
Pintado	(caja)	8422621011982	01198	12

Acabado pintado, niquelado y dorado
Barra en acero calibrado de 18 mm
Placa en acero de 2 mm
Cerradero en acero de 3 mm
Cilindro de latón de 50-70 mm de longitud

*Painted, nickel plated and golden finish
18 mm steel bar
2 mm steel plate
3 mm steel striking plate
Brass cylinder: 50-70 mm length*

*Acabamento pintado, niquelado e dourado
Barra em aço de 18 mm
Placa em aço de 2 mm
Trocador em aço de 3 mm
Cilindro em latão de 50-70 mm de longitude*



Llave de 7 claves Exterior
7 pins key - External
Chave de 7 pinos

Bombillo 70 mm		Código de Barras	Ref.	Embalaje
201R / 80				
Pintado	(caja)	8422621015034	01503	12
Niquelado	(caja)	8422621015041	01504	12
Dorado	(caja)	8422621015058	01505	12
201R G.C.M.				
Niquelado	(caja)	8422621015874	01587	12
201R U.F.G.				
Pintado	(caja)	8422621015898	01589	12
201R C.Y.-II				
Pintado	(caja)	8422621015805	01580	12

Acabado pintado, niquelado y dorado
Barra en acero calibrado de 14 mm
Placa en acero de 2 mm
Cerradero en acero de 3 mm
Cilindro de latón de 40-70-90 mm de longitud

Painted, nickel plated and golden finish

14 mm steel bar

2 mm steel plate

3 mm steel striking plate

Brass cylinder: 40-70-90 mm length

Acabamento pintado, niquelado e dourado

Barra em aço de 14 mm

Placa em aço de 2 mm

Trocador em aço de 3 mm

Cilindro em latão de 40-70-90 mm de longitud

Acabado niquelado
Barra en pletina de acero de 25x10 mm
Placa en acero de 2 mm
Cerradero en acero de 3 mm
Cilindro de latón de 40-70-90 mm.de longitud

Nickel plated finish

Steel bar of 25x10 mm

2 mm steel plate

3 mm steel striking plate

Brass cylinder: 40-70-90 mm length

Acabamento niquelado

Barra em aço de 25x10 mm

Placa em aço de 2 mm

Trocador em aço de 3 mm

Cilindro em latão de 40-70-90 mm de longitud

FAC 300 R / 80 SISTEMA R



A 87
B 75
C 44
D 117
E 26
F 142
G 40
70
90

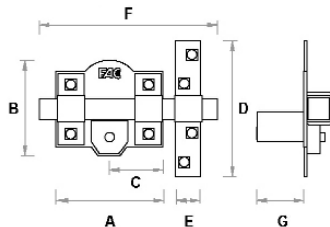

Llave de 6 claves exterior
6 pins key - External
Chave de 6 pinos



Bombillo 40 mm

	Código de Barras	Ref.	Embalaje
Pintado (caja)	8422621011043	01104	12
Niquelado (caja)	8422621011050	01105	12
(blister)	8422621013054	01305	6
Dorado (caja)	8422621011067	01106	12
(blister)	8422621013061	01306	6

Bombillo 70 mm

	Código de Barras	Ref.	Embalaje
Pintado (caja)	8422621015065	01506	12
Niquelado (caja)	8422621015072	01507	12
Dorado (caja)	8422621015089	01508	12

Bombillo 90 mm

	Código de Barras	Ref.	Embalaje
Pintado (caja)	8422621018066	01806	6
Niquelado (caja)	8422621018073	01807	6
Dorado (caja)	8422621018080	01808	6

FAC 300 R - U.E. Hidroeléctrica Aguas Cuenca SISTEMA R

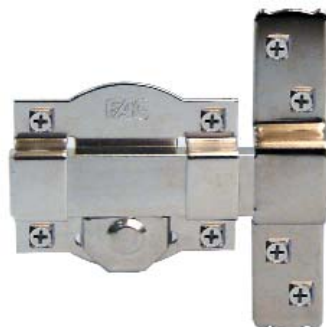

A 85
B 78
C 43
D 126
E 26
F 112
G 40
70
90

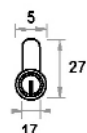
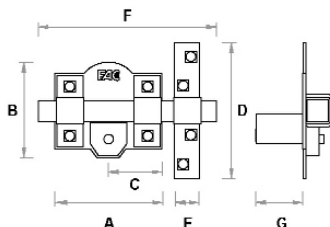

Llave exterior dentada
External jagged key
Chave dentada

Bombillo 40 mm

	Código de Barras	Ref.	Embalaje
300R U.E.			
Niquelado (derecha)	8422621011807	01180	12
(izquierda)	8422621011814	01181	12
300R U.E sin ACC			
Niquelado (derecha)	8422621011845	01184	4
(izquierda)	8422621011852	01185	4
300R HIDRO			
Niquelado (derecha)	8422621011821	01182	12
(izquierda)	8422621011838	01183	12
300R A. CUENCA			
Niquelado (derecha)	8422621012040	01204	12
(izquierda)	8422621012057	01205	12

Bombillo 70 mm

	Código de Barras	Ref.	Embalaje
300R U.E.			
Niquelado (derecha)	8422621015652	01565	12
(izquierda)	8422621015669	01566	12
300R HIDRO			
Niquelado (derecha)	8422621015676	01567	12
(izquierda)	8422621015683	01568	12

Bombillo 90 mm

	Código de Barras	Ref.	Embalaje
300R U.E			
Niquelado (derecha)	8422621018653	01865	12
(izquierda)	8422621018660	01866	12

FAC 301 R / 80 SISTEMA R

CERROJOS LOCKING BOLTS FERROLHOS

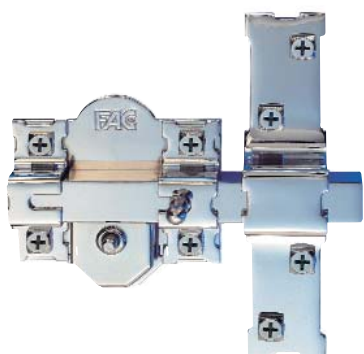

Bombillo 50 mm

		Código de Barras	Ref.	Embalaje
Pintado	(caja)	8422621011104	01110	12
Niquelado	(caja)	8422621011111	01111	12
	(blister)	8422621013115	01311	6
Dorado	(caja)	8422621011128	01112	12
	(blister)	8422621013122	01312	6

Acabado pintado, niquelado y dorado
Barra en acero calibrado de 18 mm
Placa en acero de 2 mm
Cerradero en acero de 3 mm
Cilindro de latón de 50-70-90 mm de longitud

Painted, nickel plated and golden finish

*18 mm steel bar
2 mm steel plate
3 mm steel striking plate
Brass cylinder: 50-70-90 mm length*

Acabamento pintado, niquelado e dourado

*Barra em aço de 18 mm
Placa em aço de 2 mm
Trocador em aço de 3 mm
Cilindro em latão de 50-70-90 mm de longitude*

- A 85
- B 83
- C 42
- D 150
- E 33
- F 142
- G 50
- 70
- 90

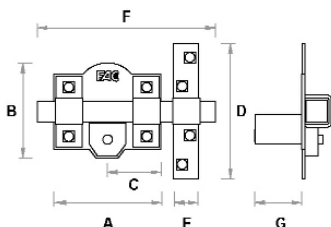

Llave de 7 claves Exterior
7 pins key - External
Chave de 7 pinos

Bombillo 70 mm

		Código de Barras	Ref.	Embalaje
Pintado	(caja)	8422621015126	01512	12
Niquelado	(caja)	8422621015133	01513	12
Dorado	(caja)	8422621015140	01514	12

Bombillo 90 mm

		Código de Barras	Ref.	Embalaje
Pintado	(caja)	8422621018127	01812	6
Niquelado	(caja)	8422621018134	01813	6
Dorado	(caja)	8422621018141	01814	6

FAC 301 R / 120 SISTEMA R

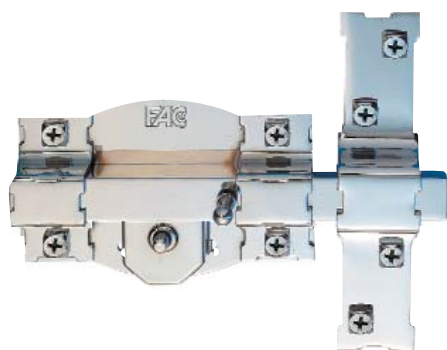

Bombillo 50 mm

		Código de Barras	Ref.	Embalaje
Pintado	(caja)	8422621011197	01119	12
Niquelado	(caja)	8422621011203	01120	12
Dorado	(caja)	8422621011210	01121	12

Acabado pintado, niquelado y dorado
Barra en acero calibrado de 18 mm
Placa en acero de 2 mm
Cerradero en acero de 3 mm
Cilindro de latón de 50-70-90 mm de longitud

Painted, nickel plated and golden finish

*18 mm steel bar
2 mm steel plate
3 mm steel striking plate
Brass cylinder: 50-70-90 mm length*

Acabamento pintado, niquelado e dourado

*Barra em aço de 18 mm
Placa em aço de 2 mm
Trocador em aço de 3 mm
Cilindro em latão de 50-70-90 mm de longitude*

- A 120
- B 80
- C 60
- D 150
- E 33
- F 175
- G 50
- 70
- 90

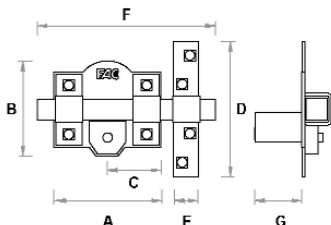

Llave de 7 claves Exterior
7 pins key - External
Chave de 7 pinos

Bombillo 70 mm

		Código de Barras	Ref.	Embalaje
Pintado	(caja)	8422621015188	01518	12
Niquelado	(caja)	8422621015195	01519	12
Dorado	(caja)	8422621015201	01520	12

Bombillo 90 mm

		Código de Barras	Ref.	Embalaje
Pintado	(caja)	8422621018189	01818	6
Niquelado	(caja)	8422621018196	01819	6
Dorado	(caja)	8422621018202	01820	6

FAC 305 R / 80
SISTEMA R

Acabado pintado y niquelado
Barra de acero calibrado de 18 mm
Placa de acero de 2 mm
Cerradero en acero de 3 mm
Cilindro de latón de 50-70-90 mm de longitud
Sistema con efecto resbalón

Painted and nickel plated finish
18 mm steel bar
2 mm steel plate
3 mm steel striking plate
Brass cylinder: 50-70-90 mm length
Latch system

Acabamento pintado e niquelado
Barra em aço de 18 mm
Placa em aço de 2 mm
Trocaador em aço de 3 mm
Cilindro em latão de 50-70-90 mm de longitude
Sistema com mecanismo de deslizamento

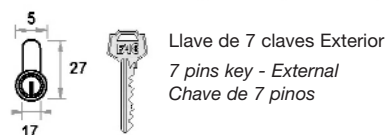
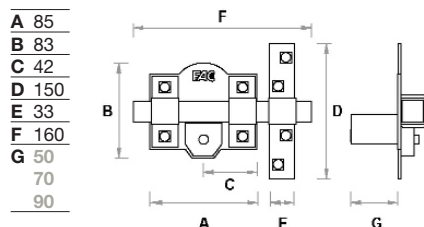
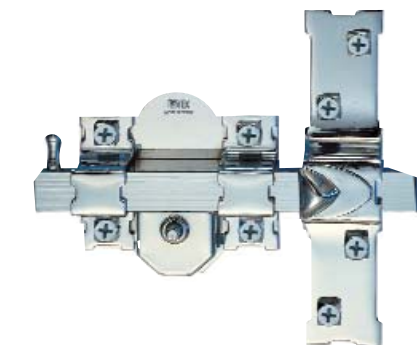

Bombillo 50 mm

305R / 80	Código de Barras	Ref.	Embalaje
Pintado	(derecha) 8422621011401	01140	12
	(izquierda) 8422621011418	01141	12
Niquelado	(derecha) 8422621011425	01142	12
	(izquierda) 8422621011432	01143	12

Bombillo 70 mm

305R / 80	Código de Barras	Ref.	Embalaje
Pintado	(derecha) 8422621015331	01533	12
	(izquierda) 8422621015348	01534	12
Niquelado	(derecha) 8422621015355	01535	12
	(izquierda) 8422621015362	01536	12

Bombillo 90 mm

305R / 80	Código de Barras	Ref.	Embalaje
Pintado	(derecha) 8422621018332	01833	6
	(izquierda) 8422621018349	01834	6
Niquelado	(derecha) 8422621018356	01835	6
	(izquierda) 8422621018363	01836	6

FAC 307 R / 80
SISTEMA R

Acabado niquelado y dorado
Barra de acero calibrado de 18 mm
Placa de acero de 2 mm
Cerradero en acero de 3 mm
Cilindro de latón de 50-70-90 mm de longitud
Cadena retenedora con eslabones de Ø 3 mm

Nickel plated and golden finish
18 mm steel bar
2 mm steel plate
3 mm steel striking plate
Brass cylinder: 50-70-90 mm length
Ø 3 mm welded chain retainer

Acabamento niquelado e dourado
Barra em aço de 18 mm
Placa em aço de 2 mm
Trocaador em aço de 3 mm
Cilindro em latão de 50-70-90 mm de longitude
Corrente de segurança com anéis de 3 mm de espessura

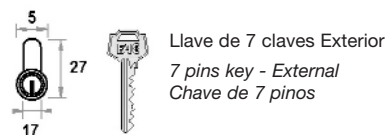
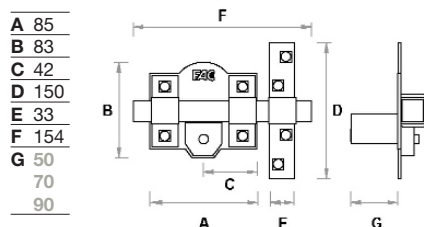
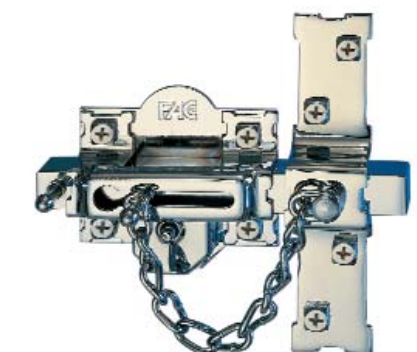

Bombillo 50 mm

	Código de Barras	Ref.	Embalaje
Niquelado (caja)	(derecha) 8422621011562	01156	12
	(izquierda) 8422621011579	01157	12
	(caja)		
Niquelado (Blister)	(derecha) 8422621013566	01356	6
	(izquierda) 8422621013573	01357	6
	(caja)		
Dorado (caja)	(derecha) 8422621011586	01158	12
	(izquierda) 8422621011593	01159	12
	(caja)		
Dorado (Blister)	(derecha) 8422621013580	01358	6
	(izquierda) 8422621013597	01359	6
	(caja)		

Bombillo 70 mm

	Código de Barras	Ref.	Embalaje
Niquelado	(derecha) 8422621015454	01545	12
	(izquierda) 8422621015461	01546	12
Dorado	(derecha) 8422621015478	01547	12
	(izquierda) 8422621015485	01548	12

Bombillo 90 mm

	Código de Barras	Ref.	Embalaje
Niquelado	(derecha) 8422621018455	01845	6
	(izquierda) 8422621018462	01846	6
Dorado	(derecha) 8422621018479	01847	6
	(izquierda) 8422621018486	01848	6



308 R / 80 SISTEMA R

CERROJOS LOCKING BOLTS FERROLHOS

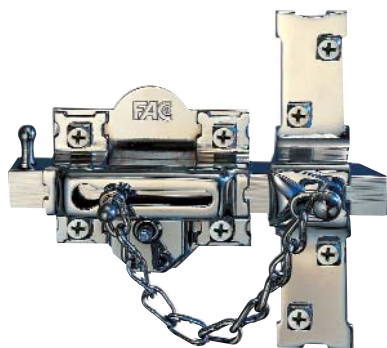

Bombillo 50 mm

		Código de Barras	Ref.	Embalaje
Niquelado	(derecha)	8422621011647	01164	12
	(izquierda)	8422621011654	01165	12
Dorado	(derecha)	8422621011661	01166	12
	(izquierda)	8422621011678	01167	12

Bombillo 70 mm

		Código de Barras	Ref.	Embalaje
Niquelado	(derecha)	8422621015492	01549	12
	(izquierda)	8422621015508	01550	12
Dorado	(derecha)	8422621015515	01551	12
	(izquierda)	8422621015522	01552	12

Bombillo 90 mm

		Código de Barras	Ref.	Embalaje
Niquelado	(derecha)	8422621018493	01849	6
	(izquierda)	8422621018509	01850	6
Dorado	(derecha)	8422621018516	01851	6
	(izquierda)	8422621018523	01852	6

A 85
B 83
C 42
D 150
E 33
F 160
G 50
70
90

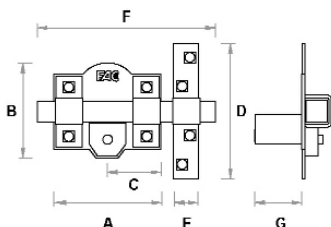

Llave de 7 claves Exterior
7 pins key - External
Chave de 7 pinos

Acabado níquelado y dorado
Barra de acero calibre de 18 mm
Placa de acero de 2 mm
Cerradero en acero de 3 mm
Cilindro de latón de 50-70-90 mm de longitud
Cadena retenedora con eslabones de Ø 3 mm

*Nickel plated and golden finish
18 mm steel bar
2 mm steel plate
3 mm steel striking plate
Brass cylinder: 50-70-90 mm length
Ø 3 mm, welded chain retainer*

*Acabamento níquelado e dourado
Barra em aço de 18 mm
Placa em aço de 2 mm
Trocaador em aço de 3 mm
Cilindro em latão de 50-70-90 mm de longitude
Corrente de segurança com anéis de 3 mm de espessura*



427 R / 65 SISTEMA R

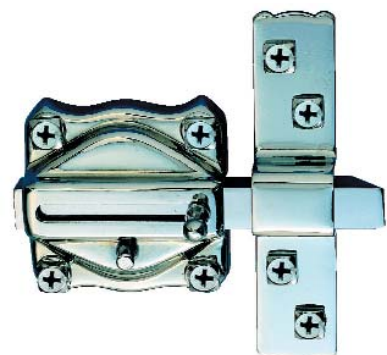

Bombillo 40 mm

		Código de Barras	Ref.	Embalaje
Niquelado	(derecha)	8422621011746	01174	12
	(izquierda)	8422621011753	01175	12

Bombillo 70 mm

		Código de Barras	Ref.	Embalaje
Niquelado	(derecha)	8422621015539	01553	12
	(izquierda)	8422621015546	01554	12

Bombillo 90 mm

		Código de Barras	Ref.	Embalaje
Niquelado	(derecha)	8422621018530	01853	12
	(izquierda)	8422621018547	01854	12

A 65
B 65
C 33
D 117
E 26
F 120
G 40
70
90

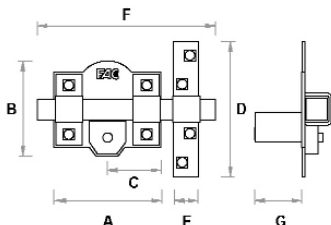

Llave de 6 claves Exterior
6 pins key - External
Chave de 6 pinos

Acabado níquelado
Barra de acero calibre de 14 mm
Placa de acero de 1,5 mm
Cerradero en acero de 3 mm
Cilindro de latón de 40-70-90 mm de longitud
Sistema de efecto resbalón

*Nickel plated finish
14 mm steel bar
1,5 mm steel plate
3 mm steel striking plate
Brass cylinder: 40-70-90 mm length
Latch system*

*Acabamento níquelado
Barra em aço de 14 mm
Placa em aço de 1,5 mm
Trocaador em aço de 3 mm
Cilindro em latão de 40-70-90 mm de longitude
Sistema con mecanismo de deslizamiento*

Acabado niquelado
Barra de acero calibrado de 14 mm
Placa de acero de 1,5 mm
Cerradero en acero de 3 mm
Cilindro de latón de 40-70-90 mm de longitud

Nickel plated finish
14 mm steel bar
1,5 mm steel plate
3 mm steel striking plate
Brass cylinder: 40-70-90 mm length

Acabamento niquelado
Barra em aço de 14 mm
Placa em aço de 1,5 mm
Trocaador em aço de 3 mm
Cilindro em latão de 40-70-90 mm de longitud

FAC 428 R / 65
SISTEMA R

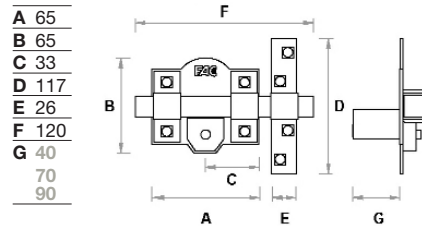

Llave de 6 claves Exterior
6 pins key - External
Chave de 6 pinos

Bombillo 40 mm

	Código de Barras	Ref.	Embalaje
Niquelado	(caja) 8422621011777	01177	12

Bombillo 70 mm

	Código de Barras	Ref.	Embalaje
Niquelado	(caja) 8422621015560	01556	12

Bombillo 90 mm

	Código de Barras	Ref.	Embalaje
Niquelado	(caja) 8422621018561	01856	12

FAC 101 RP / 105
SISTEMA R

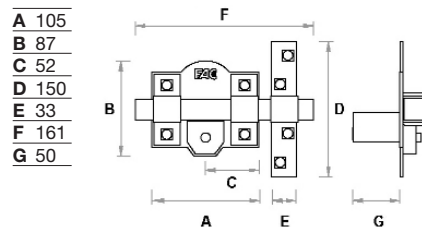
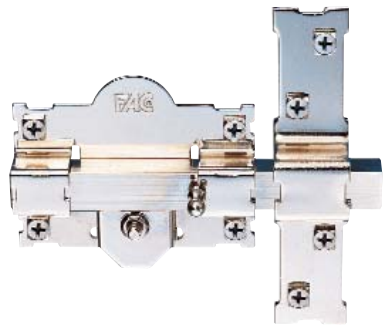

Llave de 6 claves Exterior
6 pins security key - External
Chave de 6 pinos

Bombillo 50 mm

	Código de Barras	Ref.	Embalaje
Niquelado	(caja) 8422621010640	01064	12
Pintado	(caja) 8422621010633	01063	12

Acabado pintado y niquelado
Barra de acero calibrado de 18 mm
Placa de acero de 2 mm
Cerradero en acero de 3 mm
Cilindro de latón de 50 mm de longitud

Painted and nickel plated finish
18 mm steel bar
2 mm steel plate
3 mm steel striking plate
Brass cylinder: 50 mm length

Acabamento pintado e niquelado
Barra em aço de 18 mm
Placa em aço de 2 mm
Trocaador em aço de 3 mm
Cilindro em latão de 50 mm de longitud



301 RP / 80 - RCP / 80 SISTEMA R

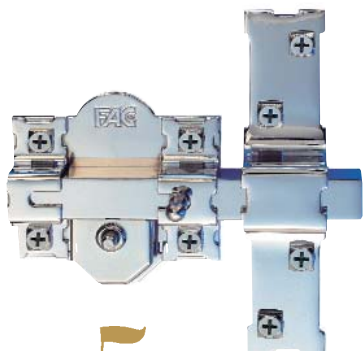

5 AÑOS
GARANTIA

A 85
B 83
C 42
D 150
E 33
F 142
G 50
70

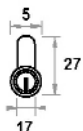
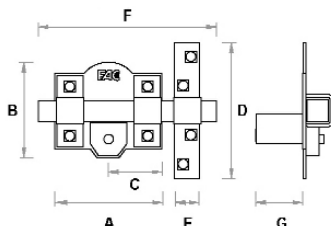

Llave de 6 claves Exterior
6 pins security key - External
Chave de 6 pinos

Bombillo 50 mm

		Código de Barras	Ref.	Emb.
①	Niquelado (caja)	8422621011142	01114	12
	(blister)	8422621013146	01314	12
	Dorado (caja)	8422621011159	01115	12
	(blister)	8422621013153	01315	12
	Cromo sat. (caja)	8422621011135	01113	12
	Níquel completo (caja)	8422621011005	01100	12
	Niquelado RCP (caja)	8422621011012	01101	12
②	Dorado RCP (caja)	8422621011029	01102	12

Bombillo 70 mm

		Código de Barras	Ref.	Emb.
①	Niquelado (caja)	8422621015706	01570	12
	Dorado (caja)	8422621015713	01571	12

Bombillo 90 mm

		Código de Barras	Ref.	Emb.
①	Niquelado (caja)	8422621018707	01870	12
	Dorado (caja)	8422621018714	01871	12

Bombillo 100 mm

		Código de Barras	Ref.	Emb.
①	Niquelado (caja)	8422621019513	01951	12
	Dorado (caja)	8422621019520	01952	12

Bombillo 120 mm

		Código de Barras	Ref.	Emb.
①	Niquelado (caja)	8422621019612	01961	12
	Dorado (caja)	8422621019629	01962	12

CERROJOS LOCKING BOLTS FERROLHOS

15

Acabado niquelado, dorado y cromo satinado
Barra de acero calibrado de 18 mm
Placa de acero de 2 mm
Cerradero en acero de 3 mm
Cilindro de latón de 50-70-90-100-120 mm de longitud

Nickel plated, golden and satin chromed finish
18 mm steel bar
2 mm steel plate
3 mm steel striking plate
Brass cylinder:
50-70-90-100-120 mm length

Acabamento niquelado, dourado e níquel acetinado
Barra em aço de 18 mm
Placa em aço de 2 mm
Trocador em aço de 3 mm
Cilindro em latão de 50-70-90-100-120 mm de longitude



305 RP / 80 SISTEMA R

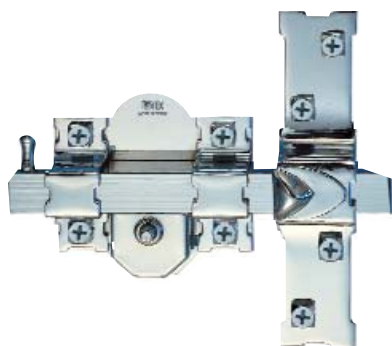

5 AÑOS
GARANTIA

A 85
B 83
C 42
D 150
E 33
F 160
G 50

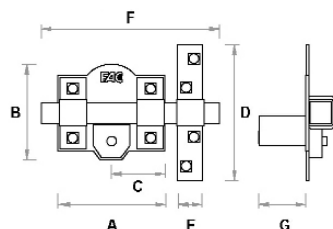

Llave de 6 claves Exterior
6 pins security key - External
Chave de 6 pinos

Bombillo 50 mm

		Código de Barras	Ref.	Embalaje
Niquelado	(derecha)	8422621011463	01146	1
	(izquierda)	8422621011470	01147	1

Acabado niquelado
Barra de acero calibrado de 18 mm
Placa de acero de 2 mm
Cerradero en acero de 3 mm
Cilindro de latón de 50 mm de longitud
Sistema con efecto resbalón

Nickel plated finish
18 mm steel bar
2 mm steel plate
3 mm steel striking plate
Brass cylinder: 50 mm length
Latch system

Acabamento niquelado
Barra em aço de 18 mm
Placa em aço de 2 mm
Trocador em aço de 3 mm
Cilindro em latão de 50 mm de longitude
Sistema con mecanismo de deslizamiento

Acabado niquelado y dorado
Barra de acero calibrado de 18 mm
Placa de acero de 2 mm
Cerradero en acero de 3 mm
Cilindro de latón de 50-70 mm
de longitud
Cadena retenedora con eslabones
de Ø 3 mm

Nickel plated and golden finish
18 mm steel bar
2 mm steel plate
3 mm steel striking plate
Brass cylinder: 50-70 mm length
Ø 3 mm welded chain retainer

Acabamento niquelado e dourado
Barra em aço de 18 mm
Placa em aço de 2 mm
Trocaador em aço de 3 mm
Cilindro em latão de 50-70 mm
de longitude
Corrente de segurança com anéis de
3 mm de espessura

FAC 307 RP / 80
SISTEMA R

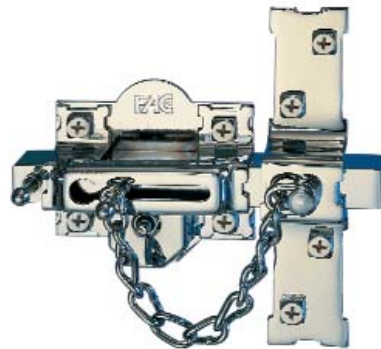

A	85
B	83
C	42
D	150
E	33
F	154
G	50
	70

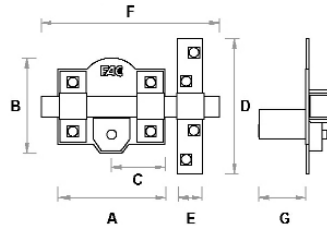

Llave de 6 claves Exterior
6 pins security key - External
Chave de 6 pinos



Bombillo 50 mm

	Código de Barras	Ref.	Embalaje
Niquelado (caja)	(derecha) 8422621011609	01160	12
	(izquierda) 8422621011616	01161	12
Niquelado (blister)	(derecha) 8422621013603	01360	6
	(izquierda) 8422621013610	01361	6
Dorado (caja)	(derecha) 8422621011623	01162	12
	(izquierda) 8422621011630	01163	12
Dorado (blister)	(derecha) 8422621013627	01362	6
	(izquierda) 8422621013634	01363	6

Bombillo 70 mm

	Código de Barras	Ref.	Embalaje
Niquelado (caja)	(derecha) 8422621015720	01572	12
	(izquierda) 8422621015737	01573	12
Dorado (caja)	(derecha) 8422621015744	01574	12
	(izquierda) 8422621015751	01575	12

FAC 308 RP / 80
SISTEMA R

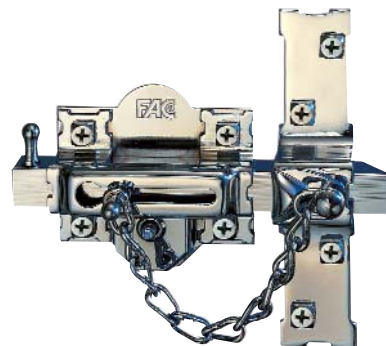

A	85
B	83
C	42
D	150
E	33
F	160
G	50
	70

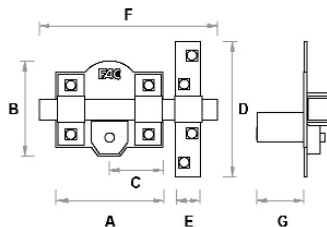

Llave de 6 claves Exterior
6 pins security key - External
Chave de 6 pinos



Bombillo 50 mm

	Código de Barras	Ref.	Embalaje
Niquelado (caja)	(derecha) 8422621011685	01168	12
	(izquierda) 8422621011692	01169	12
Dorado (caja)	(derecha) 8422621011708	01170	12
	(izquierda) 8422621011715	01171	12

Bombillo 70 mm

	Código de Barras	Ref.	Embalaje
Niquelado (caja)	(derecha) 8422621015768	01576	12
	(izquierda) 8422621015775	01577	12
Dorado (caja)	(derecha) 8422621015782	01578	12
	(izquierda) 8422621015799	01579	12

Acabado niquelado y dorado
Barra de acero calibrado de 18 mm
Placa de acero de 2 mm
Cerradero en acero de 3 mm
Cilindro de latón de 50-70 mm
de longitud
Cadena retenedora con eslabones
de Ø 3 mm

Nickel plated and golden finish
18 mm steel bar
2 mm steel plate
3 mm steel striking plate
Brass cylinder: 50-70 mm length
Ø 3 mm welded chain retainer

Acabamento niquelado e dourado
Barra em aço de 18 mm
Placa em aço de 2 mm
Trocaador em aço de 3 mm
Cilindro em latão de 50-70 mm
de longitude
Corrente de segurança com anéis de
3 mm de espessura

FAC 101 L / 105 SISTEMA L

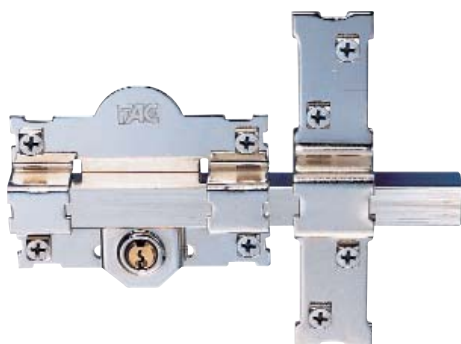

- A 105
- B 87
- C 52
- D 150
- E 33
- F 183
- G 50
- 70

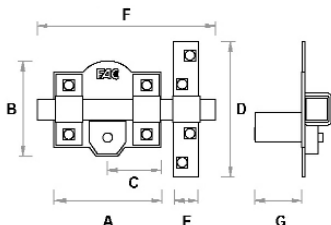

Llave de 7 claves
Exterior/interior
7 pins key - External/internal
Chave de 7 pinos

Bombillo 50 mm

		Código de Barras	Ref.	Embalaje
Pintado	(caja)	8422621010503	01050	12
Niquelado	(caja)	8422621010510	01051	12

Bombillo 70 mm

		Código de Barras	Ref.	Embalaje
Pintado	(caja)	8422621015584	01558	12
Niquelado	(caja)	8422621015607	01560	12

Bombillo 90 mm

		Código de Barras	Ref.	Embalaje
Pintado	(caja)	8422621018585	01858	12
Niquelado	(caja)	8422621018608	01860	12

CERROJOS LOCKING BOLTS FERROLHOS

Acabado pintado y niquelado
Barra de acero calibrado de 18 mm
Placa de acero de 2 mm
Cerradero en acero de 3 mm
Cilindro de latón de 50-70 mm de longitud

*Painted and nickel plated finish
18 mm steel bar.
2 mm steel plate
3 mm steel striking plate
Brass cylinder: 50-70 mm length*

*Acabamento pintado e niquelado
Barra em aço de 18 mm
Placa em aço de 2 mm
Trocador em aço de 3 mm
Cilindro em latão de 50-70 mm de longitude*

FAC 201 L / 80 SISTEMA L

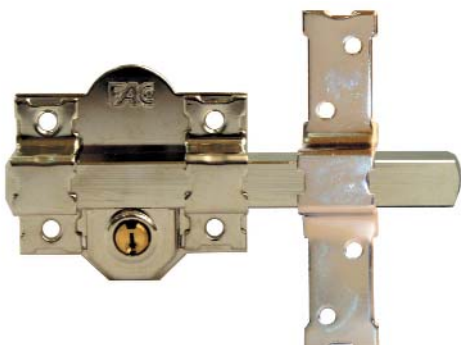

- A 85
- B 82
- C 42
- D 150
- E 33
- F 165
- G 50
- 70

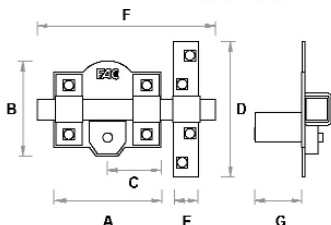

Llave de 7 claves
Exterior/interior
7 pins key - External/internal
Chave de 7 pinos

Bombillo 50 mm

		Código de Barras	Ref.	Embalaje
Pintado	(caja)	8422621011890	01189	12
Niquelado	(caja)	8422621011906	01190	12
Dorado	(caja)	8422621011913	01191	12

Bombillo 70 mm

		Código de Barras	Ref.	Embalaje
Pintado	(caja)	8422621015003	01500	12
Niquelado	(caja)	8422621015010	01501	12
Dorado	(caja)	8422621015027	01502	12

Acabado pintado, niquelado y dorado
Barra de acero calibrado de 18 mm
Placa de acero de 2 mm
Cerradero en acero de 3 mm
Cilindro de latón de 50-70 mm de longitud

*Painted, nickel plated and golden finish
18 mm steel bar
2 mm steel plate
3 mm steel striking plate
Brass cylinder: 50-70 mm length*

*Acabamento pintado, niquelado e dourado
Barra em aço de 18 mm
Placa em aço de 2 mm
Trocador em aço de 3 mm
Cilindro em latão de 50-70 mm de longitude*

FAC 301 L / 80
SISTEMA L

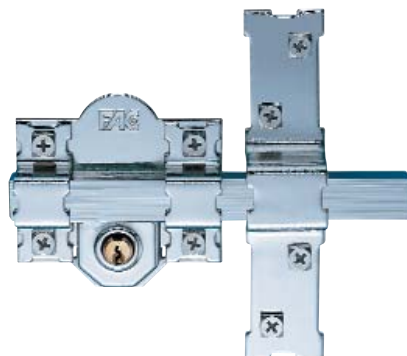

Acabado pintado, niquelado y dorado
Barra de acero calibrado de 18 mm
Placa de acero de 2 mm
Cerradero en acero de 3 mm
Cilindro de latón de 50-70 mm de longitud

Painted, nickel plated and golden finish

18 mm steel bar.
2 mm steel plate
3 mm steel striking plate
Brass cylinder: 50-70 mm length

Acabamento pintado, niquelado e dourado

Barra em aço de 18 mm
Placa em aço de 2 mm
Trocaador em aço de 3 mm
Cilindro em latão de 50-70 mm de longitude

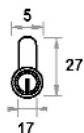
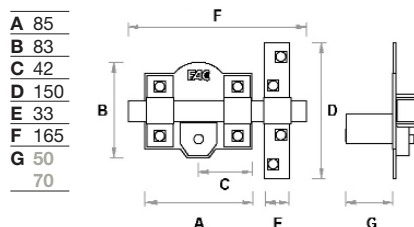

Llave de 7 claves
Exterior/interior
7 pins key - External/internal
Chave de 7 pinos

Bombillo 50 mm

	Código de Barras	Ref.	Embalaje
Pintado (caja)	8422621011074	01107	12
Niquelado (caja)	8422621011081	01108	12
	8422621013085	01308	6
Dorado (caja)	8422621011098	01109	12
	8422621013092	01309	6

Bombillo 70 mm

	Código de Barras	Ref.	Embalaje
Pintado (caja)	8422621015096	01509	12
Niquelado (caja)	8422621015102	01510	12
Dorado (caja)	8422621015119	01511	12

FAC 301 L / 120
SISTEMA L

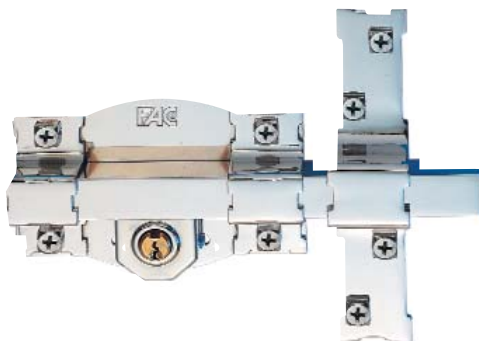

Acabado pintado, niquelado y dorado
Barra de acero calibrado de 18 mm
Placa de acero de 2 mm
Cerradero en acero de 3 mm
Cilindro de latón de 50-70 mm de longitud

Painted, nickel plated and golden finish

18 mm steel bar.
2 mm steel plate
3 mm steel striking plate
Brass cylinder: 50-70 mm length

Acabamento pintado, niquelado e dourado

Barra em aço de 18 mm
Placa em aço de 2 mm
Trocaador em aço de 3 mm
Cilindro em latão de 50-70 mm de longitude

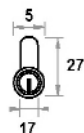
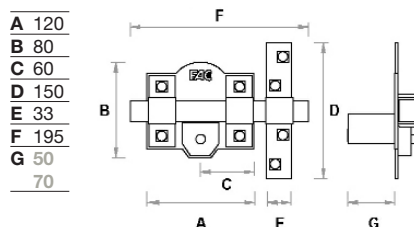

Llave de 7 claves
Exterior/interior
7 pins key - External/internal
Chave de 7 pinos

Bombillo 50 mm

	Código de Barras	Ref.	Embalaje
Pintado (caja)	8422621011166	01116	12
Niquelado (caja)	8422621011173	01117	12
Dorado (caja)	8422621011180	01118	12

Bombillo 70 mm

	Código de Barras	Ref.	Embalaje
Pintado (caja)	8422621015157	01515	12
Niquelado (caja)	8422621015164	01516	12
Dorado (caja)	8422621015171	01517	12



302 L / 115 SISTEMA L

CERROJOS
LOCKING BOLTS
FERROLHOS



A	115
B	90
C	54
D	150
E	33
F	195
G	50
	70

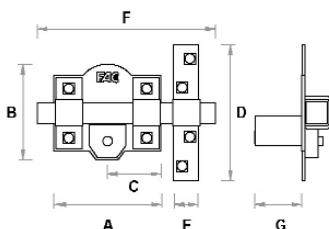

Llave de 7 claves
Exterior/interior

7 pins key - External/internal
Chave de 7 pinos

Bombillo 50 mm

		Código de Barras	Ref.	Embalaje
Pintado	(derecha)	8422621011227	01122	12
	(izquierda)	8422621011234	01123	12
Niquelado	(derecha)	8422621011241	01124	12
	(izquierda)	8422621011258	01125	12

Bombillo 70 mm

		Código de Barras	Ref.	Embalaje
Pintado	(derecha)	8422621015218	01521	12
	(izquierda)	8422621015225	01522	12
Niquelado	(derecha)	8422621015232	01523	12
	(izquierda)	8422621015249	01524	12

Acabado pintado y niquelado
Barra de acero calibre de 18 mm
Placa de acero de 2 mm
Cerradero en acero de 3 mm
Cilindro de latón de 50-70 mm
de longitud

Painted and nickel plated finish
18 mm steel bar
2 mm steel plate
3 mm steel striking plate
Brass cylinder: 50-70 mm length

Acabamento pintado e niquelado
Barra em aço de 18 mm
Placa em aço de 2 mm
Trocador em aço de 3 mm
Cilindro em latão de 50-70 mm
de longitude



303 L / 115 SISTEMA L

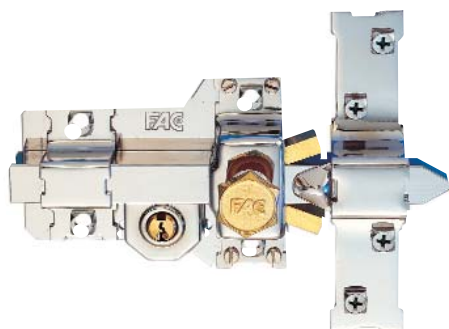

A	115
B	90
C	54
D	150
E	33
F	188
G	50
	70

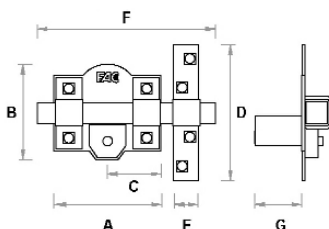

Llave de 7 claves
Exterior/interior

7 pins key - External/internal
Chave de 7 pinos

Bombillo 50 mm

		Código de Barras	Ref.	Embalaje
Pintado	(derecha)	8422621011302	01130	12
	(izquierda)	8422621011319	01131	12
Niquelado	(derecha)	8422621011326	01132	12
	(izquierda)	8422621011333	01133	12

Bombillo 70 mm

		Código de Barras	Ref.	Embalaje
Pintado	(derecha)	8422621015270	01527	6
	(izquierda)	8422621015287	01528	6
Niquelado	(derecha)	8422621015294	01529	6
	(izquierda)	8422621015300	01530	6

Acabado pintado y niquelado
Barra de acero calibre de 18 mm
Placa de acero de 2 mm
Cerradero en acero de 3 mm
Cilindro de latón de 50-70 mm
de longitud

Painted and nickel plated finish
18 mm steel bar
2 mm steel plate
3 mm steel striking plate
Brass cylinder: 50-70 mm length

Acabamento pintado e niquelado
Barra em aço de 18 mm
Placa em aço de 2 mm
Trocador em aço de 3 mm
Cilindro em latão de 50-70 mm
de longitude

CERROJOS
LOCKING BOLTS
FERROLHOS

Acabado pintado y niquelado
Barra de acero calibrado de 18 mm
Placa de acero de 2 mm
Cerradero en acero de 3 mm
Cilindro de latón de 50-70 mm de longitud
Sistema con efecto resbalón

Painted and nickel plated finish
18 mm steel bar
2 mm steel plate
3 mm steel striking plate
Brass cylinder: 50-70 mm length
Latch system

Acabamento pintado e niquelado
Barra em aço de 18 mm
Placa em aço de 2 mm
Trocaador em aço de 3 mm
Cilindro em latão de 50-70 mm de longitude
Sistema com mecanismo de deslizamiento

FAC 306 L / 115
SISTEMA L

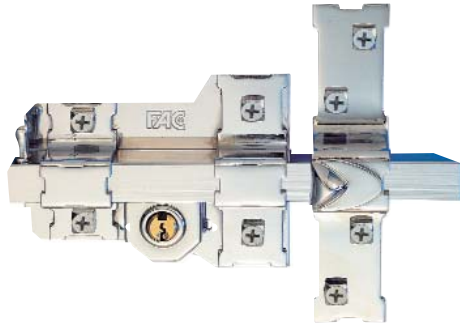

- A 115
- B 90
- C 53
- D 150
- E 33
- F 195
- G 50
- 70

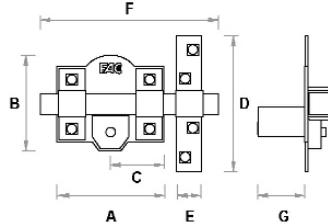

Llave de 5 claves
Exterior/interior
5 pins key - External/internal
Chave de 5 pinos

Bombillo 50 mm

		Código de Barras	Ref.	Embalaje
Pintado	(derecha)	8422621011487	01148	12
	(izquierda)	8422621011494	01149	12
Niquelado	(derecha)	8422621011500	01150	12
	(izquierda)	8422621011517	01151	12

Bombillo 70 mm

		Código de Barras	Ref.	Embalaje
Pintado	(derecha)	8422621015379	01537	12
	(izquierda)	8422621015386	01538	12
Niquelado	(derecha)	8422621015393	01539	12
	(izquierda)	8422621015409	01540	12

FAC 307 L / 80
SISTEMA L



Acabado niquelado y dorado
Barra de acero calibrado de 18 mm
Placa de acero de 2 mm
Cerradero en acero de 3 mm
Cilindro de latón de 50-70 mm de longitud
Cadena retenedora con eslabones de Ø 3 mm

Nickel plated and golden finish
18 mm steel bar
2 mm steel plate
3 mm steel striking plate
Brass cylinder: 50-70 mm length
Ø 3 mm welded chain retainer

Acabamento niquelado e dourado
Barra em aço de 18 mm
Placa em aço de 2 mm
Trocaador em aço de 3 mm
Cilindro em latão de 50-70 mm de longitude
Corrente de segurança com anéis de 3 mm de espessura

- A 85
- B 83
- C 42
- D 150
- E 33
- F 165
- G 50
- 70

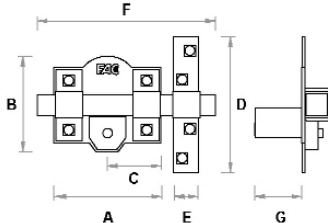

Llave de 7 claves
Exterior/interior
7 pins key - External/internal
Chave de 7 pinos

Bombillo 50 mm

		Código de Barras	Ref.	Embalaje
Niquelado (caja)	(derecha)	8422621011524	01152	12
	(izquierda)	8422621011531	01153	12
Niquelado (blister)	(derecha)	8422621013528	01352	6
	(izquierda)	8422621013535	01353	6

Dorado (caja)	(derecha)	8422621011548	01154	12
	(izquierda)	8422621011555	01155	12
Dorado (blister)	(derecha)	8422621013542	01354	6
	(izquierda)	8422621013559	01355	6

Bombillo 70 mm

		Código de Barras	Ref.	Embalaje
Niquelado	(derecha)	8422621015416	01541	12
	(izquierda)	8422621015423	01542	12
Dorado	(derecha)	8422621015430	01543	12
	(izquierda)	8422621015447	01544	12



301 LP / 80 SISTEMA L

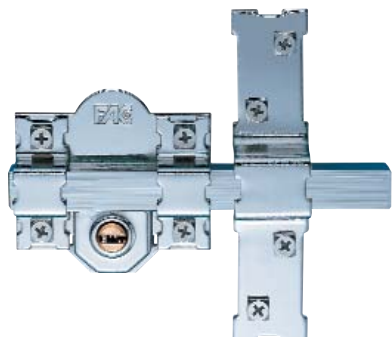

Bombillo 50 mm

A	85
B	83
C	42
D	150
E	33
F	165
G	50

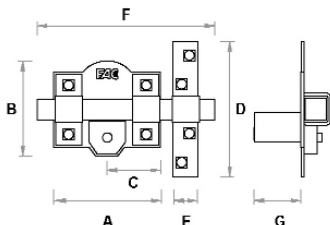

	Código de Barras	Ref.	Embalaje
Niquelado	(caja) 8422621012101	01210	12
Dorado	(caja) 8422621012118	01211	12



Llave de 6 claves
Exterior/interior
6 pins key - External/internal
Chave de 6 pinos

CERROJOS LOCKING BOLTS FERROLHOS

Acabado niquelado y dorado
Barra de acero calibrado de 18 mm
Placa de acero de 2 mm
Cerradero en acero de 3 mm
Cilindro de latón de 50 mm
de longitud

Nickel plated and golden finish
18 mm steel bar
2 mm steel plate
3 mm steel striking plate
Brass cylinder: 50 mm length

Acabamento niquelado e dourado
Barra em aço de 18 mm
Placa em aço de 2 mm
Trocaador em aço de 3 mm
Cilindro em latão de 50 mm
de longitude



304 DF / 130 SISTEMA L



Bombillo 28 mm

A	130
B	75
C	65
D	-
E	-
F	208
G	28

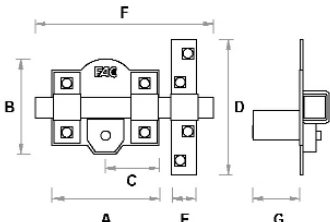

	Código de Barras	Ref.	Embalaje
Niquelado	8422621011395	01139	12
Juego de 2			



Llave de 6 claves Exterior
6 pins key - External
Chave de 6 pinos

Acabado niquelado
Barra en pletina de acero calibrado
de 25x10 mm
Placa de acero de 2 mm
Cilindro de latón de 28 mm
de longitud

Nickel plated finish
Steel bar of 25x10 mm
2 mm steel plate
Brass cylinder: 28 mm length

Acabamento niquelado
Barra em aço de 25x10 mm
Placa em aço de 2 mm
Cilindro em latão de 28 mm
de longitude

FAC 302 T / 115
SISTEMA T



Acabado niquelado
Barra de acero calibrado de 18 mm
Placa de acero de 2 mm
Cerradero en acero de 3 mm
Cilindro de latón de 50-70-90 mm de longitud

Nickel plated finish
18 mm steel bar
2 mm steel plate
3 mm steel striking plate
Brass cylinder: 50-70-90 mm length

Acabamento niquelado
Barra em aço de 18 mm
Placa em aço de 2 mm
Trocador em aço de 3 mm
Cilindro em latão de 50-70-90 mm de longitude

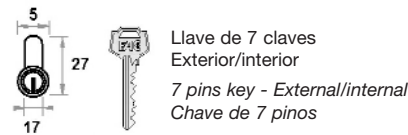
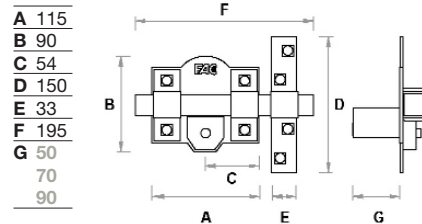

Llave de 7 claves
Exterior/interior
7 pins key - External/internal
Chave de 7 pinos

Bombillo 50 mm

	Código de Barras	Ref.	Embalaje
Niquelado (derecha)	8422621011289	01128	12
(izquierda)	8422621011296	01129	12

Bombillo 70 mm

	Código de Barras	Ref.	Embalaje
Niquelado (derecha)	8422621015256	01525	12
(izquierda)	8422621015263	01526	12

Bombillo 90 mm

	Código de Barras	Ref.	Embalaje
Niquelado (derecha)	8422621018257	01825	12
(izquierda)	8422621018264	01826	12

FAC 303 T / 115
SISTEMA T

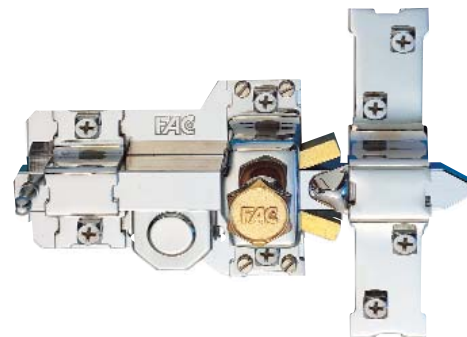

Acabado niquelado
Barra de acero calibrado de 18 mm
Placa de acero de 2 mm
Cerradero en acero de 3 mm
Cilindro de latón de 50-70-90 mm de longitud

Nickel plated finish
18 mm steel bar
2 mm steel plate
3 mm steel striking plate
Brass cylinder: 50-70-90 mm length

Acabamento niquelado
Barra em aço de 18 mm
Placa em aço de 2 mm
Trocador em aço de 3 mm
Cilindro em latão de 50-70-90 mm de longitude

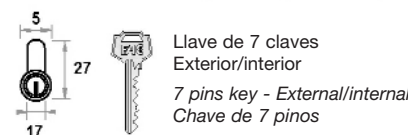
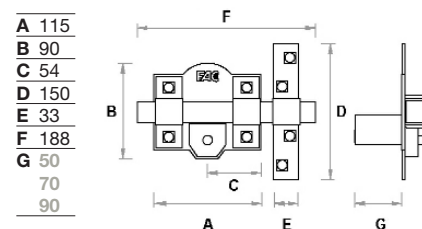

Llave de 7 claves
Exterior/interior
7 pins key - External/internal
Chave de 7 pinos

Bombillo 50 mm

	Código de Barras	Ref.	Embalaje
Niquelado (derecha)	8422621011364	01136	12
(izquierda)	8422621011371	01137	12

Bombillo 70 mm

	Código de Barras	Ref.	Embalaje
Niquelado (derecha)	8422621015317	01531	6
(izquierda)	8422621015324	01532	6

Bombillo 90 mm

	Código de Barras	Ref.	Embalaje
Niquelado (derecha)	8422621018318	01831	6
(izquierda)	8422621018325	01832	6



304 F / 130

SISTEMA T



- A 130
- B 75
- C 65
- D -
- E -
- F 208
- G 28

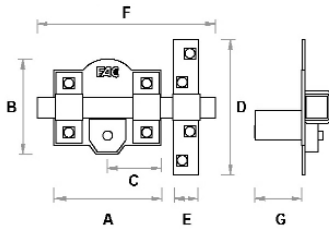

Bombillo 28 mm

	Código de Barras	Ref.	Embalaje
Niquelado	8422621011388	01138	12
Juego de 2			



Llave de 6 claves Exterior
6 pins key - External
Chave de 6 pinos

CERROJOS LOCKING BOLTS FERROLHOS

Acabado niquelado
Barra en pletina de acero calibrado de 25x10 mm
Placa de acero de 2 mm
Cilindro de latón de 28 mm de longitud

*Nickel plated finish
Steel bar of 25x10 mm
2 mm steel plate
Brass cylinder: 28 mm length*

Acabamento niquelado
Barra em aço de 25x10 mm
Placa em aço de 2 mm
Cilindro em latão de 28 mm de longitude



304 FP / 130

SISTEMA T



- A 130
- B 75
- C 65
- D -
- E -
- F 208
- G 28

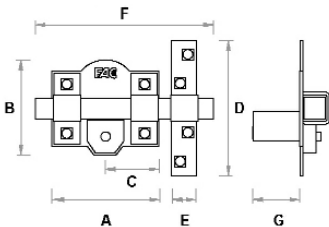

Bombillo 28 mm

	Código de Barras	Ref.	Embalaje
Niquelado	8422621010992	01099	12
Juego de 2			



Llave de 6 claves Exterior/interior
6 pins key - External/internal
Chave de 6 pinos

Acabado niquelado
Barra en pletina de acero calibrado de 25x10 mm
Placa de acero de 2 mm
Cilindro de latón de 28 mm de longitud

*Nickel plated finish
Steel bar of 25x10 mm
2 mm steel plate
Brass cylinder: 28 mm length*

Acabamento niquelado
Barra em aço de 25x10 mm
Placa em aço de 2 mm
Cilindro em latão de 28 mm de longitude

NOVEDAD



Conjunto de seguridad clónico

Compuesto por cerrojo y cilindro de perfil europeo fabricados con llaves de puntos o planas.

Las claves del cilindro de perfil europeo y las del cerrojo son diferentes.

Cada componente se suministra con su propia llave y a su vez se facilita una llave denominada LLAVE DE FAMILIA que abre ambos dispositivos.

Cilindros disponibles:

40x30 LLAVE/POMO - LEVA 15

40x40 LLAVE/LLAVE - LEVA 15

35x35 LLAVE/LLAVE - LEVA 15

Puede solicitarse con otro modelo de cerrojo de llaves planas.

Master key security set

Composed by one locking bolt and one europrofile cylinder to be operated with security keys.

The cylinder and the lock key codes are different.

Each item has its own key and an extra master key called "FAMILY KEY" is supplied to operate both locking devices.

Available cylinders:

40x30 KEY/KNOB - 15 mm CAM

40x40 KEY/KEY - 15 mm CAM

35x35 KEY/KEY - 15 mm CAM.

Available with any other locking bolt operated with security key

(under request).

Conjunto de segurança clónico

Formado por um ferrolho e cilindro de perfil europeu fabricados com chaves de pontos ou dentadas.

Os segredos do cilindro de perfil europeu e os do ferrolho são diferentes.

Cada componente é fornecido com a sua própria chave e ainda com uma chave denominada CHAVE DE FAMÍLIA que abre ambos os dispositivos.

Cilindros disponíveis:

40x30 Chave/Manípulo, lingueta 15

40x40 Chave/Chave, lingueta 15

35x35 Chave/Chave, lingueta 15.

Pode fornecer-se com outro modelo de ferrolho de chaves dentadas.

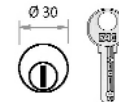
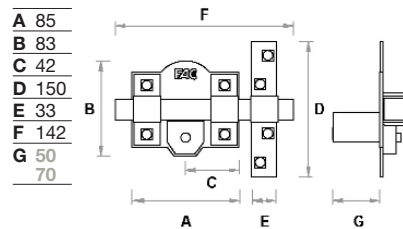

Llave de 6 claves Exterior
6 pins security key - External
Chave de 6 pinos

	Código de Barras	Ref.	Embalaje
Cilindro perfil europeo latón 40x30 mm Llave exterior / Pomo cromado interior Leva 15 mm	8422621012125	01212	1
Cerrojo 301-LP/80 niquelado Llave exterior / interior			
Cilindro perfil europeo latón 40x30 mm Llave exterior / Pomo dorado interior Leva 15 mm	8422621012132	01213	1
Cerrojo 301-LP/80 dorado Llave exterior / interior			
Cilindro perfil europeo latón 40x40 mm Llave exterior / interior Leva 15 mm	8422621012163	01216	1
Cerrojo 301-RP/80 niquelado Llave exterior / pulsador y tirador interior			
Cilindro perfil europeo latón 40x40 mm Llave exterior / interior Leva 15 mm	8422621012170	01217	1
Cerrojo 301-RP/80 dorado Llave exterior / pulsador y tirador interior			
Cilindro perfil europeo latón 35x35 mm Llave exterior / interior Leva 15 mm	8422621012262	01226	1
Cerrojo 301-RP/80 niquelado Llave exterior / pulsador y tirador interior			
Cilindro perfil europeo latón 35x35 mm Llave exterior / interior Leva 15 mm	8422621012279	01227	1
Cerrojo 301-RP/80 dorado Llave exterior / pulsador y tirador interior			



CONJUNTO DE SEGURIDAD MISMA CLAVE

CERROJOS
LOCKING BOLTS
FERROLHOS

NOVEDAD

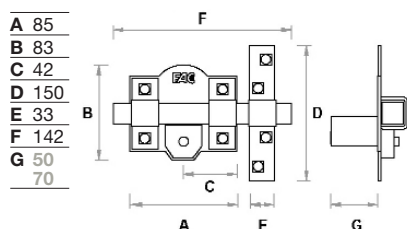
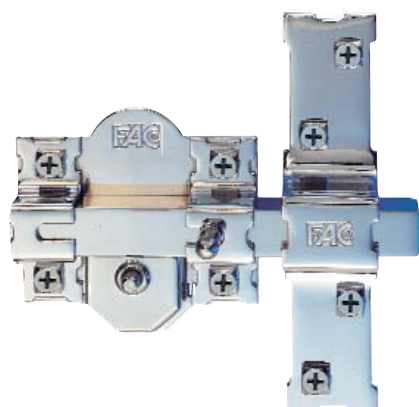

Llave de 6 claves Exterior
 6 pins security key - External
 Chave de 6 pinos

Conjunto de seguridad misma clave

Compuesto por cerrojo y cilindro de perfil europeo fabricados con llaves de puntos o planas.

Las claves del cilindro de perfil europeo y las del cerrojo son iguales.

Cualquier llave del conjunto abre tanto el cilindro de perfil europeo como el cerrojo.

Cilindros disponibles:

40x30 LLAVE/POMO - LEVA 15

40x40 LLAVE/LLAVE - LEVA 15

35x35 LLAVE/LLAVE - LEVA 15

Puede solicitarse con otro modelo de cerrojo de llaves planas.

Key alike security set

Composed by one locking bolt and one europrofile cylinder to be operated with security keys.

The cylinder and the lock key codes are alike.

The same key operates both the europrofile cylinder and the locking bolt.

Available cylinders:

40x30 KEY/KNOB - 15 mm CAM

40x40 KEY/KEY - 15 mm CAM

35x35 KEY/KEY - 15 mm CAM

Available with any other locking bolt operated with security key

(under request).

Conjunto de segurança Mesma Chave

Formado por um ferrolho e cilindro de perfil europeu fabricados com chaves de pontos ou dentadas.

Os segredos do cilindro de perfil europeu e os do ferrolho são iguais.

Qualquer chave do conjunto abre tanto o cilindro de perfil europeu como o ferrolho.

Cilindros disponíveis:

40x30 Chave/Manipulo, lingueta 15

40x40 Chave/Chave, lingueta 15

35x35 Chave/Chave, lingueta 15.

Pode fornecer-se com outro modelo de ferrolho de chaves dentadas.

	Código de Barras	Ref.	Embalaje
Cilindro perfil europeo latón 40x30 mm Llave exterior / Pomo cromado interior Leva 15 mm	8422621012149	01214	1
Cerrojo 301-LP/80 niquelado Llave exterior / interior			
Cilindro perfil europeo latón 40x30 mm Llave exterior / Pomo dorado interior Leva 15 mm	8422621012156	01215	1
Cerrojo 301-LP/80 dorado Llave exterior / interior			
Cilindro perfil europeo latón 40x40 mm Llave exterior / interior Leva 15 mm	8422621012187	01218	1
Cerrojo 301-RP/80 niquelado Llave exterior / pulsador y tirador interior			
Cilindro perfil europeo latón 40x40 mm Llave exterior / interior Leva 15 mm	8422621012194	01219	1
Cerrojo 301-RP/80 dorado Llave exterior / pulsador y tirador interior			
Cilindro perfil europeo latón 35x35 mm Llave exterior / interior Leva 15 mm	8422621012286	01228	1
Cerrojo 301-RP/80 niquelado Llave exterior / pulsador y tirador interior			
Cilindro perfil europeo latón 35x35 mm Llave exterior / interior Leva 15 mm	8422621012293	01229	1
Cerrojo 301-RP/80 dorado Llave de puntos exterior / pulsador y tirador interior			
Cilindro perfil europeo latón 40x40 mm Llave exterior / interior Leva 15 mm	8422621012309	01230	1
Cerrojo 301-RP/80 níquel completo Llave exterior / pulsador y tirador interior			
Cilindro perfil europeo latón 35x35 mm Llave exterior / interior Leva 15 mm	8422621012316	01231	1
Cerrojo 301-RP/80 níquel completo Llave exterior / pulsador y tirador interior			

CERROJOS
LOCKING BOLTS
FERROLHOS

26

Acabado niquelado y dorado
Barra de acero calibre de 18 mm
Placa de acero de 2 mm
Cerradero en acero de 3 mm
Cadena retenedora con eslabones de Ø 3 mm

Nickel plated and golden finish
18 mm steel bar
2 mm steel plate
3 mm steel striking plate
Ø 3 mm welded chain retainer

Acabamento niquelado e dourado
Barra em aço de 18 mm
Placa em aço de 2 mm
Trocaador em aço de 3 mm
Corrente de segurança com anéis de 3 mm de espessura

FAC P 86
PASADOR

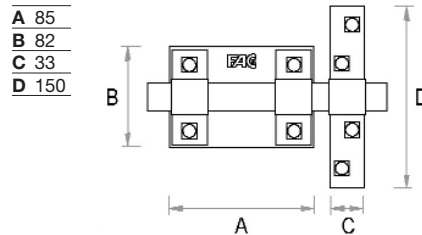

	Código de Barras	Ref.	Embalaje
Niquelado (caja)	8422621121117	12111	1
Dorado (caja)	8422621121124	12112	1
Niquelado (blister)	8422621121148	12114	1
Dorado (blister)	8422621121155	12115	1
Cromo satinado (blister)	8422621121162	12116	1

FAC P 87
PASADOR

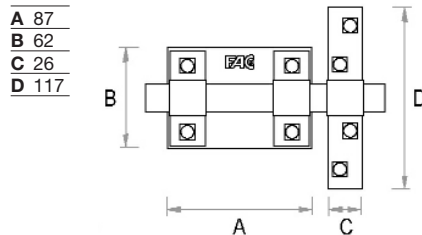
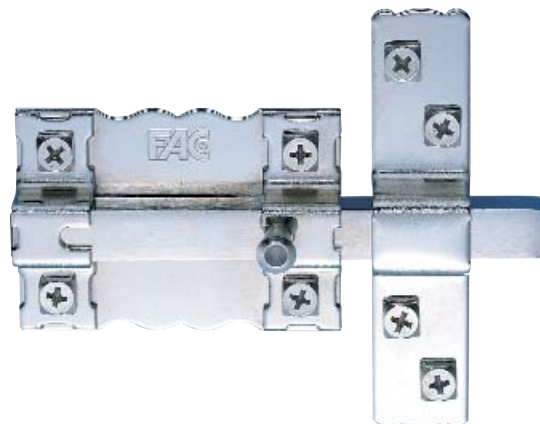

	Código de Barras	Ref.	Embalaje
Niquelado (caja)	8422621121018	12101	1
Niquelado (blister)	8422621121049	12104	1
Dorado (caja)	8422621121025	12102	1
Dorado (blister)	8422621121032	12103	1
Oxido (blister)	8422621121056	12105	1
Negro oxidón (blister)	8422621121063	12106	1
Cromo satinado (blister)	8422621121070	12107	1

Acabado niquelado y dorado
Barra de acero calibre de 14 mm
Placa de acero de 2 mm
Cerradero en acero de 3 mm

Nickel plated and golden finish
14 mm steel bar
2 mm steel plate
3 mm steel striking plate

Acabamento niquelado e dourado
Barra em aço de 14 mm
Placa em aço de 2 mm
Trocaador em aço de 3 mm

Colocación a derecha, izquierda o vertical indistintamente.
Se acciona tirando del tirador que desbloquea la barra

Possibility of mounting right, left or vertical. It's worked throwing of the knob that unlocks the bar

Montagem á direita, esquerda ou vertical indistintamente.
É accionando retirando o puxador que desbloqueia a barra



P 88 PASADOR

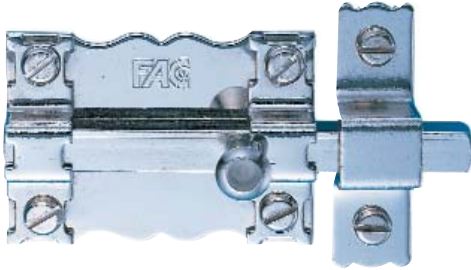

A 56
B 40
C 15
D 50

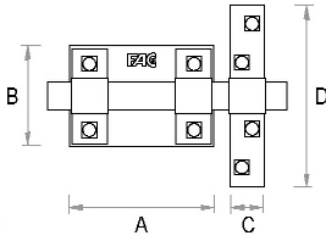

	Código de Barras	Ref.	Embalaje
Niquelado	8422621121926	12192	12
Dorado	8422621121933	12193	12

Colocación a derecha, izquierda o vertical indistintamente.
Se acciona tirando del tirador que desbloquea la barra
Possibility of mounting righth, left or vertical. It's worked throwing of the knob that unlocks the bar
Montagem á direita, esquerda ou vertical indistintamente.
É accionando retirando o puxador que desbloqueia a barra

CERROJOS LOCKING BOLTS FERROLHOS

Acabado niquelado y dorado
Barra de acero calibrado de 8 mm
Placa de acero de 1,5 mm
Cerradero en acero de 1,5 mm
Sólo disponible en blíster

Nickel plated and golden finish
8 mm steel bar
1,5 mm steel plate
1,5 mm steel striking plate
Only available in blister

Acabamento niquelado e dourado
Barra em aço de 8 mm
Placa em aço de 1,5 mm
Trocaador em aço de 1,5 mm
Em Blister



P 89 PASADOR



A 32
B 30
C 12
D 40

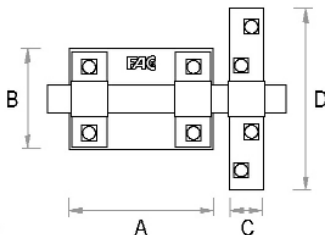

	Código de Barras	Ref.	Embalaje
Niquelado	8422621121940	12194	12
Dorado	8422621121957	12195	12

Colocación a derecha, izquierda o vertical indistintamente.
Se acciona tirando del tirador que desbloquea la barra
Possibility of mounting righth, left or vertical. It's worked throwing of the knob that unlocks the bar
Montagem á direita, esquerda ou vertical indistintamente.
É accionando retirando o puxador que desbloqueia a barra

Acabado niquelado y dorado
Barra de acero calibrado de 8 mm
Placa de acero de 1,5 mm
Cerradero en acero de 1,5 mm
Sólo disponible en blíster

Nickel plated and golden finish
8 mm steel bar
1,5 mm steel plate
1,5 mm steel striking plate
Only available in blister

Acabamento niquelado e dourado
Barra em aço de 8 mm
Placa em aço de 1,5 mm
Trocaador em aço de 1,5 mm
Em Blister

CERROJOS
LOCKING BOLTS
FERROLHOS

Innovador sistema anti-impacto
Fabricado en acero 100% tallado
en torno CNC y cortado en laser
Muelle interno destinado a absorber
la energía del impacto
Acabados: cromo brillo, cromo
satinado y dorado
Sólo disponible en blíster

*An innovating anti-impact system
Made in 100% steel worked in a
winch CNC and laser cutting
Internal spring to absorb the
impact energy
Finish: polished chromo, satin
chrome and golden finish
Only available in blister*

*Um inovador sistema anti-impacto
Fabricado em aço 100% modelado
em torno CNC e cortado com laser
Mola interna destinada a absorver a
energia do impacto
Acabamentos em cromo brilhante,
cromo acetinado e dourado
Em Blister*

FAC RETENEDOR
ANTI-IMPACTO

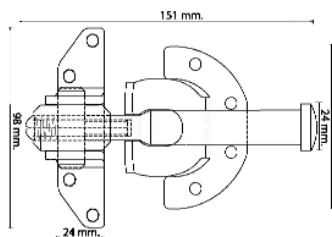
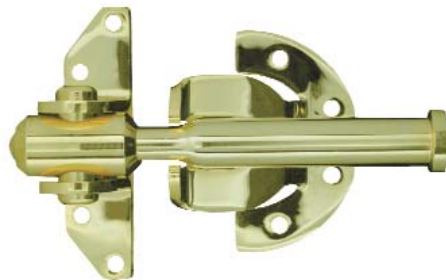

	Código de Barras	Ref.	Embalaje
Cromo satinado	8422621033557	03355	6
Dorado	8422621033564	03356	6
Cromado	8422621033571	03357	6

FAC 600
RETENEDOR



Acabado níquelado y dorado
Placa en chapa de acero de 2 mm
Cadena soldada con eslabón de
Ø 3 mm

*Nickel plated and golden finish
2 mm steel plate
Ø 3 mm welded chain retainer*

*Acabamento níquelado e dourado
Placa em aço de 2 mm
Corrente de segurança com anéis
de 3 mm*

A 80
B 110
C 65
D 35

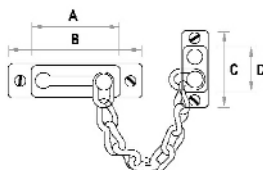

	Código de Barras	Ref.	Embalaje
Dorado	8422621033526	03352	12
Níquelado	8422621033519	03351	12

FAC 700
PIVOTES

Pivotes de acero de 13 mm
Placa de acero de 2,1 mm
Placa de acabado latonado

*13 mm steel bolts
2,1 mm steel plate
Brass plated finish*

*Trincos em aço de 13 mm
Placa em aço de 2,1 mm
Placa em acabamento latão*



	Código de Barras	Ref.	Embalaje
Juego 3	8422621085518	08551	20

“En 1931 patentamos nuestro primer cerrojo, el n° 1.
Después de 78 años y más de 20 millones
de unidades fabricadas, reeditamos el original”



ORO: bañado en oro de 18 quilates

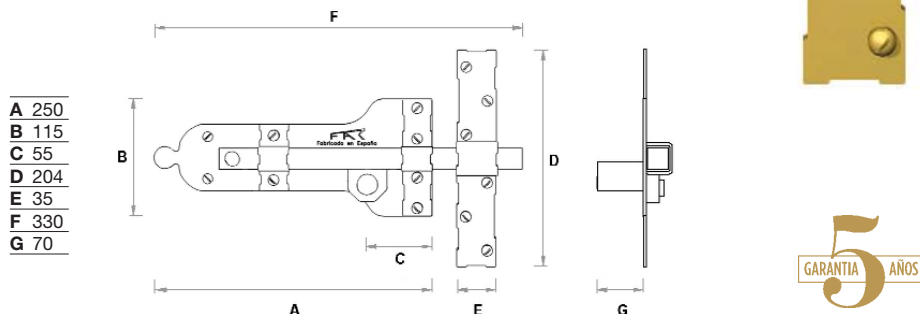

- A 250
- B 115
- C 55
- D 204
- E 35
- F 330
- G 70

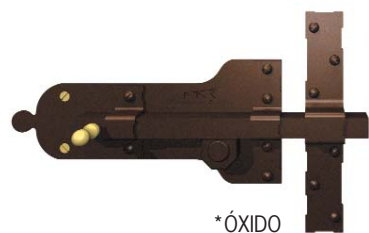

Bombillo 50 mm

	Código de Barras	Ref.	Embalaje
Óxido	(derecha)	8422621019001	01900 12
	(izquierda)	8422621019094	01909 12
Negro	(derecha)	8422621019032	01903 12
	(izquierda)	8422621019124	01912 12
Oro	(derecha)	8422621019063	01906 12
	(izquierda)	8422621019155	01915 12

Bombillo 70 mm

	Código de Barras	Ref.	Embalaje
Óxido	(derecha)	8422621019018	01901 12
	(izquierda)	8422621019100	01910 12
Negro	(derecha)	8422621019049	01904 12
	(izquierda)	8422621019131	01913 12
Oro	(derecha)	8422621019070	01907 12
	(izquierda)	8422621019162	01916 12

Bombillo 90 mm

	Código de Barras	Ref.	Embalaje
Óxido	(derecha)	8422621019025	01902 12
	(izquierda)	8422621019117	01911 12
Negro	(derecha)	8422621019056	01905 12
	(izquierda)	8422621019148	01914 12
Oro	(derecha)	8422621019087	01908 12
	(izquierda)	8422621019179	01917 12

*Acabado epoxy de alta resistencia a la corrosión



Llave de 7 claves
Exterior/internal
7 pins key - External/internal
Chave de 7 pinos

Opción en **SISTEMA L** (llave interior / exterior)
con bombillo de 50 mm, 70 mm y 90 mm

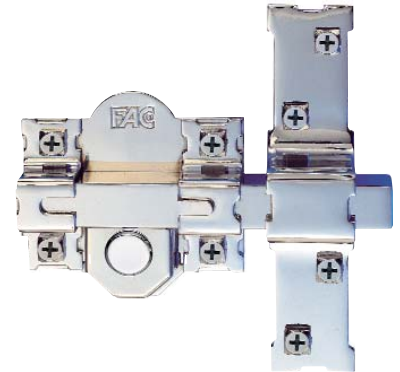

Acabado niquelado
Barra en acero calibrado de 18 mm
Placa de acero de 2 mm
Cerradero de 3 mm
Sin tirador y caja ciega (no apertura desde interior)
Escudo exterior en acero cromado en negro
Cilindro de latón de 50-70-90-100-120 mm

Nickel finish
18 mm steel bar
2 mm steel plate
3 mm steel strike plate
No handle (it can't be operated from inside)
Escutcheon made from steel in black color

Acabamento niquelado
Barra em aço de 18 mm
Placa em aço de 2 mm
Trancador em aço de 3 mm
Sem puxador e entrada do cilindro (não abre desde o interior)
Espelho exterior em aço cromado preto
Cilindro de latão de 50-70-90-100-120 mm

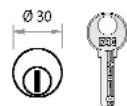
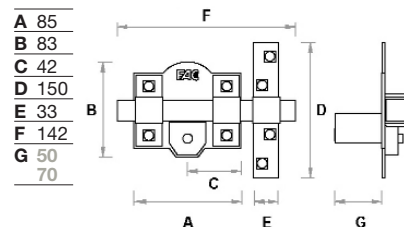

Llave de 6 claves Exterior
6 pins security key - External
Chave de 6 pinos

Bombillo 50 mm

	Código de Barras	Ref.	Embalaje
Niquelado (caja)	8422621010985	01098	1

Bombillo 70 mm

	Código de Barras	Ref.	Embalaje
Niquelado (caja)	8422621015980	01598	1

Bombillo 90 mm

	Código de Barras	Ref.	Embalaje
Niquelado (caja)	8422621018981	01898	1

Bombillo 100 mm

	Código de Barras	Ref.	Embalaje
Niquelado (caja)	8422621019506	01950	1

Bombillo 120 mm

	Código de Barras	Ref.	Embalaje
Niquelado (caja)	8422621019605	01960	1